

# مشاريع الشرق الأوسط العالمية

## Middle East International Enterprises

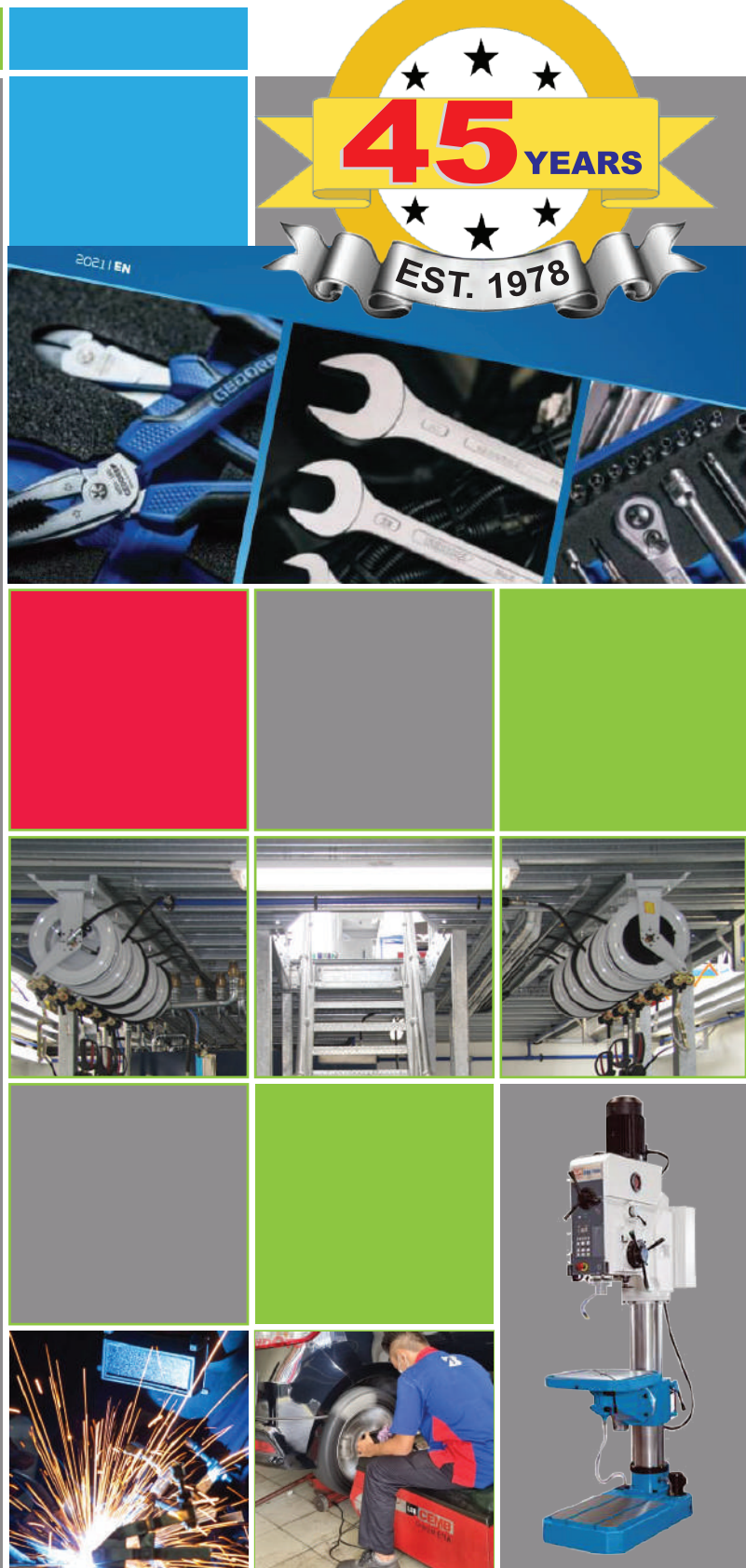

*Your first source & best choice*

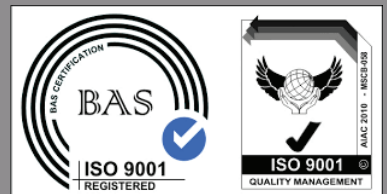



## Introduction to Middle East International Enterprise:

Middle East International Enterprises, was established in 1978. Based on years of experience and thorough market understanding in GCC, Middle East and African countries by Chairman Abdul Razaq Abdul Rahman Al Hajri founded Middle East International Enterprises, to meet the market requirement and satisfy the client's needs in a professional business manner.

We specialized in supplying, exporting, commissioning, and maintaining all Auto Service Equipment, Industrial Machineries, Construction Material, and Heavy-Duty Hand Tools for Auto Workshop, Garages and Industries.

Our dedicated professional staff (Engineers and Technicians) is committed to provide you with the best quality service and the most reliable business relationship.

Our showroom is located in a convenient location, which is easily accessible by the clients, with thousands of items in stock, guarantee fast answer and immediate delivery of the required equipment.

Years of experience backed up with professional staff, have put us amongst the top companies in our field. Satisfied clients in various sectors (Government Sector and Private Sector) in local and global market, in different industries (oil field, educational and training, and automotive) gave us an excellent reputation and strong support that motivated us to continue our superior quality work and activity.



## نبذة عن مشاريع الشرق الأوسط العالمية

التجارية الأكثر موثوقية ، وصالات معارضنا في انطباق المواقع والتي يمكن الوصول إليها بسهولة و يسر من قبل عمالنا. مع توفر جميع البضائع في مخازننا، تضمن سرعة الاستجابة والتسليم الفوري للمعدات المطلوبة.

و مع سنوات من الخبرة المتواصلة، وبالتوجيهات الحكيمة من مؤسسها سعادة عبد الرزاق عبدالرحمن الهاجري، وضعت شركتنا من بين أفضل الشركات في هذا النشاط والمجال. و برضاء وارتياح جميع عمالنا في مختلف القطاعات الحكومية والخاصة، المحلية منها والعالمية، في الصناعات المختلفة منها النفطية والتعليمية والحرفية الخ..... جعلت لشركتنا ذات سمعة ممتازة ودعم قوي الذي دفعنا إلى مواصلة عملنا بالجودة العالية.

أسس مشاريع الشرق الأوسط العالمية في عام 1978. بناءً على سنوات من الخبرة والفهم الشامل للسوق في دولة الامارات العربية المتحدة ودول مجلس التعاون الخليجي ودول الشرق الأوسط ودول إفريقيا من قبل سعادة عبدالرزاق عبدالرحمن الهاجري، أسس مشاريع الشرق الأوسط الدولية ، لتلبية متطلبات الاسواق المحلية و الدولية لتلبية احتياجات العملاء بطريقة مهنية.

نحن متخصصون في توريد وتصدير وتشغيل وصيانة جميع معدات خدمة السيارات والآلات الصناعية ومواد البناء والأدوات اليدوية الخفيفة والثقيلة لورشه السيارات (كراج) والمصانع.

ويتميز موظفينا ومهندسينا والفنيين بالخبرة المهنية المتخصصة في كافة المجالات ، لتوفير أفضل الخدمات بالجودة العالية والعلامات

## Automotive Lifter

# Automotive Lifter

### Two Post Lift

(Electro mechanical and Hydraulic)

- Asymmetric and Symmetric
- Clear Floor and Plate Floor
- Capacity:  
3, 4, 4.5, 5 Ton



### Four Post Lift

(Electro Hydraulic)

- Car, Light Truck, & Heavy Duty Truck
- Alignment Type
- Capacity: 3.5, 4, 5.5, 6, 8, 12, 15, 20 Ton

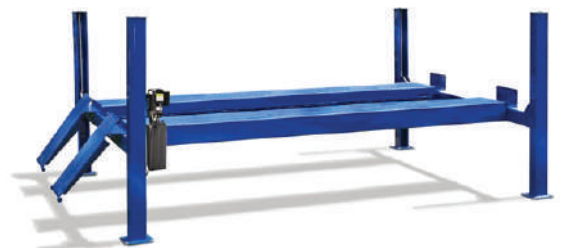

### Scissor Lift



Car, Light Truck, and Heavy Duty Truck  
Alignment Type  
Capacity: 3, 4, 5.5, 6 Ton

### Mobile Column Lift



Cord and Cordless  
Capacity per column: 3000, 4000, 5500,  
7000, 8500, 10,000 KG

### Automatic Car Parking System



## Garage Equipment

# Garage Equipment

### Engine Crane

(1, 2, 3, 4 Ton) Fixed / Folding



### Hydraulic Trolley Jack



- Short and long
- Capacity:  
2, 2.5, 3, 5, 10, 20 Ton

### Engine Stand

(1, 1.5, 2 Ton)



(2, 3, 6, 12 Ton)



(0.5, 1, 2, 4 Ton)



### Coil Spring Compressor



## Garage Equipment

# Garage Equipment

**Transmission Jack / Floor Type**  
(1, 2, 3 Ton)



**Air Operated Trolley Jack**  
(22, 50 Ton)



**Hydraulic Bottle Jack**

(5,10,15,20,30,50, 100 Ton)



**Air Operated Bottle Jack**

(30, 50, 65 Ton)



**Garage Creeper**



**Motor Cycle Lift & Motor Cycle Support**  
(Quad /ATV and Sport/Classic)

(200, 350, 400 KG)



**Parts Washing Machine**

(12, 20, 40 Gallon)



## Tyre Service Equipment

# Tyre Service Equipment

### Wheel Balancer Off Car

Digital / Monitor(Computerize) Screen  
Car, Light Truck, and Heavv Duttv Truck



### Wheel Balancer On Car

a- Laser / Flashing Type  
b- Car, Light & Heavy Duty Truck



### Tire Changer

a - Car, Light Truck, and Heavy Duty Truck  
b - Manual/Semi Automatic/Full Automatic/Touchless



### Wheel Alignment machine

a- 4, 6 Cameras / 3 D  
b- Car, Light Truck, and Heavy Duty Truck



### Low Rise Lift

(3, 4 Ton)



# Tyre Service Equipment

## Tyre Service Equipment

### Brake/Drum Lathe Machine

(Off car) Car, Light Truck, and Heavy Duty Truck



### Tire Inflator (Manual / Automatic)



### Brake/Drum Lathe Machine

(On car) Car, Light Truck, & Heavy Duty Truck



### Tire Vulcanizer

Car, Light Truck, and Heavy Duty Truck



### Brake Shoe Riveter (Pneumatic / Electrical)



### Wheel Weight

Car, Light Truck, Heavy Duty Truck  
Steel / Aluminum Rim Weight  
Sticker Weight



### Tire Repairing Kit

Car, Light Truck, and Heavy Duty Truck



### Brake Bleeder



### Nitrogen Tire Inflator

Car, Light Truck, and Heavy Duty Truck



## Lubricant Equipment

# Lubricant Equipment

### Pneumatic Pump

Oil / Grease



### Hose Reel

Air / Water / Oil / Grease  
Open and Covered



### Mobile Dispensing Kit

Oil / Grease

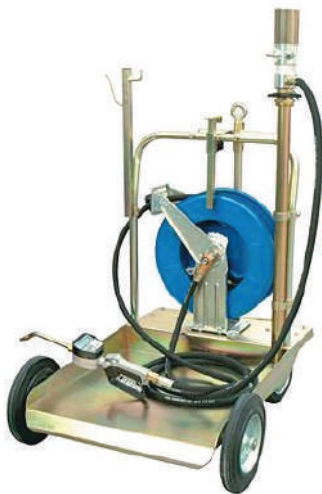

### Waste Oil Drainer

(Suction / Drainer)



### Flow Meter

Oil / Diesel / Fuel



### Oil Dispenser

(Mechanical / Digital)



## Lubricant Equipment

# Lubricant Equipment

Oil / Grease Bucket



Oil Drum Hand Operated Pump



Lever Pump Oil / Grease Suction



Oil Filter Crasher



Oil Filter Cup Wrench Set

Car, Light Truck, and Heavy Duty Truck



Oil Can



# Painting & Denting Equipment

## Painting & Denting Equip.

### Painting / Spraying and Drying Booth

- 7, 8, 9, 15, ...etc Meter
- Diesel / Petrol / Gas Burner
- Water Base Option
- Pit / Steel Basement



### Chaises Aligner Bench



### Inferred Heating Light



### Body Straighter kit



### Denting Tool



### Paint Spray Gun And Accessories



### Paint Water Separator Filter



## Compressed Air Equipment

# Compressed Air Equip.

### Air Compressor (Piston Type)

- Horizontal / Vertical
- Electrical / Petrol-Diesel Engine Driven
- Silent Type
- Capacity: 25, 50, 100, 150, 200, 300, 500, 1000 LTR



### Air Compressor (Screw Type)

- Single Unit / 3 in 1 Unit
- Capacity: 7.5, 10, 15, 20, 25, 30, 40, 50, 70, 80, 100 HP
- Air Receiver Vertical Tank 300, 500, 1000, 2000 LTR
- Air Dryer Suitable for All Screw and Piston Compressor

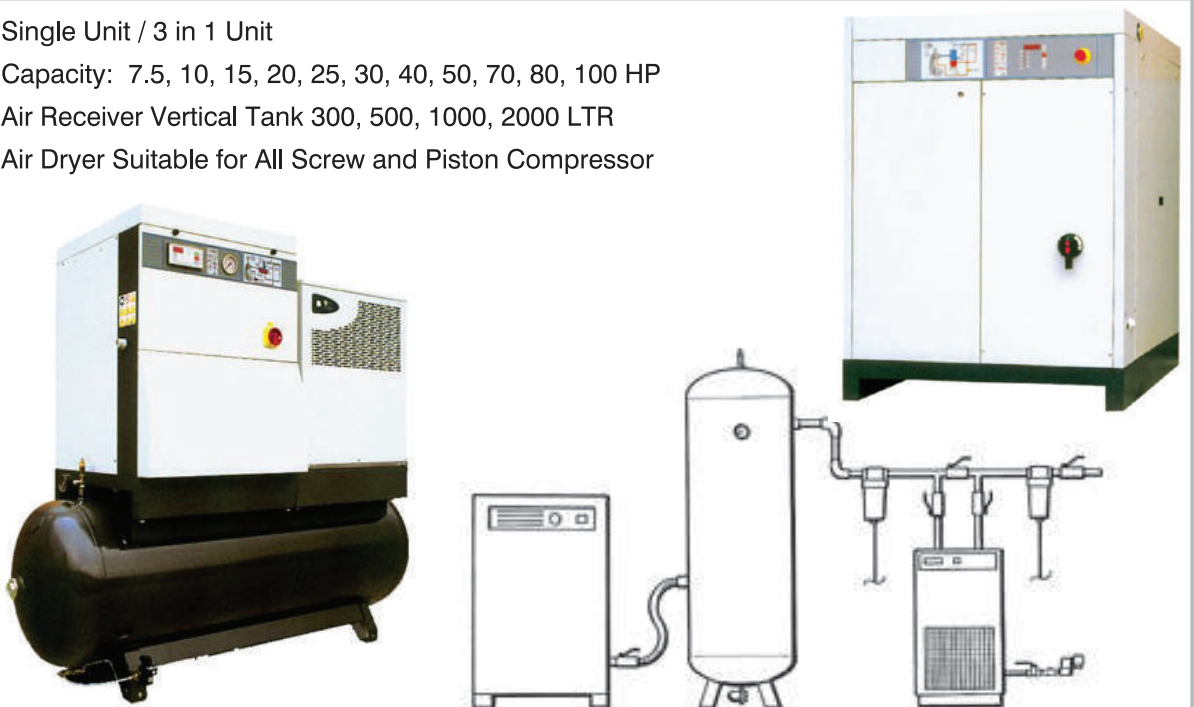

# AIR Treatment

# AIR Treatment

## Compressed Air Maintenance (Filtration – Regulation – Lubrication)



### Air Filtration



### Condensate Drain (after Filtration)



### Pressure Indication (for Regulation)



### Air Distribution



### Air Connection



### Air Control



### Air Tools



## Welding Machine & Battery Charger

# Welding Machine & Battery Charger

- **ARC Welding Machine A/C – D/C**  
(100, 200, 300, 450, 500, 600 AMP)



- **MAA Welding Machine A/C – D/C**  
(100, 200, 300, 450, 500 AMP)



- **Tig Welding Machine A/C-D/C**  
(100, 200, 300, 500 AMP)



- **Spot Welding Machine**  
(200, 300, 400, 500 AMP)



- **Mig Welding Machine A/C-D/C**  
(200, 220, 300, 400, 500 AMP)





# Washing & Cleaning Equipment

## Washing & Cleaning Equipment

### Automatic Car Wash (Brush / Brushless)

- a- Roller Type
- b- Tunnel Type

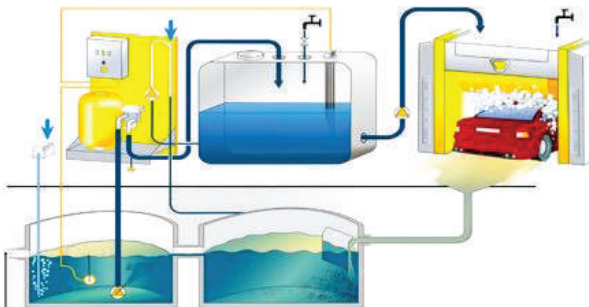

### Water Recycling Solution



### Hydraulic Service Jack

- Single / Double Plunge
- Capacity: 4, 5, 6, 8, 15 Ton

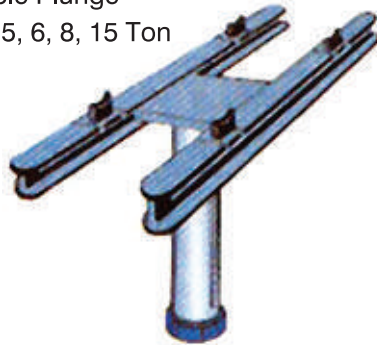

### High Pressure Machine

- Cold / Hot (Steam) Water
- Electric / Engine Driven
- Pressure: 100, 130, 160, 190, 200 BAR



### Electrical Vertical Pump for Washing

(4, 5.5, 7.5, 10, 15 HP)



## Washing & Cleaning Equipment

# Washing & Cleaning Equipment

### Vacuum Cleaner

(Medium and Heavy Duty Industrial)



### Stainless Steel Shampoo Spray Tank

(50, 90 LTR)



### • Central Vacuum Cleaner

(7.5 – 10 HP / 2, 3, 4, 6 Outlet) Local Made



### • Vacuum Cleaner Accessories



### • Car Mat Squeezer & Washer



# Testing Equipment

## Testing Equipment

### • Test Line (Light Vehicle and Truck)

- Brake Tester
- Shock Absorber Tester
- Side Slip Tester
- Play Detector

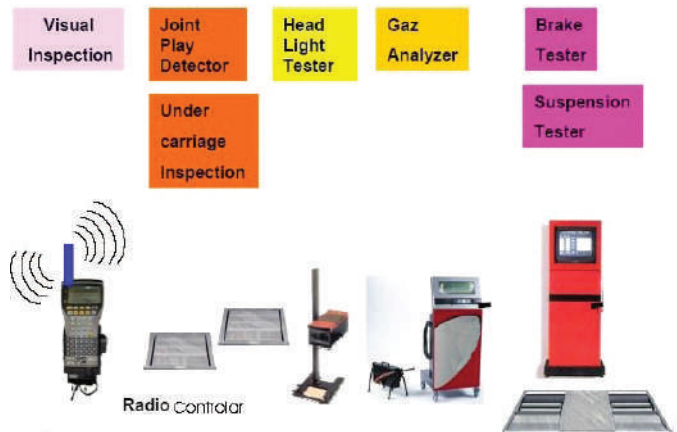
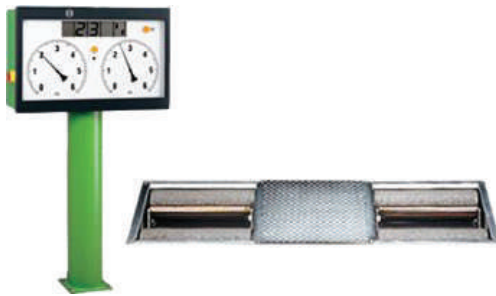

### • Exhaust Extraction System



- Sliding Trolley / Hose Reel
- Customize

### • A/C Charging Machine

(Manual / Full Automatic with Recycling)



### A/C Manifold Gauge

(134a, R 12)



# Testing Equipment

# Testing Equipment

## Head Light Tester

Car, Light Truck, and Heavy Duty Truck



## Injector Cleaner and Tester

(4, 6, 8 Nozzles)



## Jump Starter 12/24V



## Gas Trolley (Single / Twin)



# Testing Equipment

# Testing Equipment

**Radiator Cooling Tester**



**Timing Light**



**• Battery Tester**  
(Analogue / Digital)



**Automotive testing Equipment**

Compression/ Vacuum Tester  
Fuel/Diesel Injection, Pump Pressure Tester  
Transmission, Power Steering, Engine Oil Pressure Tester



**• Multimeter**  
(Analogue / Digital )



**• Scanner Diagnostic**  
(For All Cars)



# MEASURING TOOLS

# MEASURING TOOLS

## Vernier Caliper

Range  
150mm-1000mm  
6"-40"



## Dial Caliper

Range  
150mm-300mm  
6"-12"



## Digimatic Caliper

Range  
150mm-300mm  
6"-12"



## Magnetic Stand



## Digimatic Micrometers

Range  
0-30mm to 75-105mm



## Outside Micrometers

Range  
0-25mm to 475-500mm



## Depth Micrometers

Range  
0-150mm to 0-150mm



## Dial Indicators

Range  
1mm-30mm



## Dial Bore Gauge

Specification  
Material: Plastic, metal  
Measuring range: 35-50mm  
Dial Diameter: 52.2mm  
Resolution: 0.01mm  
Accuracy: 0.015mm



The bore gauges used to measure internal dimensions of work piece by comparative method. These series bore gauges are equipped with good guiding protective bridge which can be self-centering exactly and reliably. The moveable anvil on one side and interchangeable on another side, which serves for settling the bore diameters

## Test Instruments

# Test Instruments

Compact Digital Multimeter (Analogue)



Analogue Multimeter



Analogue Clamp Meters



AC/DC Clamp Meters (Analogue)



# HARDWARE TOOLS

# HARDWARE TOOLS

## Metal Cutting Disc:

Diameter	Bore	Thicknes
100MM	16MM	2.5 MM
115MM	22.2MM	1.6 MM
115MM	22.2MM	2.5 MM
125MM	22.2MM	1.6 MM
125MM	22.2MM	1.5 MM
150MM	22.2MM	2.5 MM
180MM	22.2MM	3 MM
230MM	22.2MM	3 MM



## Steel Brush



## Steel File



## Rivert Gun



## Measuring Tape

### Power Lock

Description
1 M (MM/IMP)
3 M (MM/IMP)
5 M (MM/IMP)
8 M (MM/IMP)
10 M (MM/IMP)



### Tylon

Description
3 M (MM/IMP)
5 M (MM/IMP)
8 M (MM/IMP)



# ELECTRIC WATER PUMP & ELECTRIC MOTOR

## ELECTRIC WATER PUMP & ELECTRIC MOTOR

### Electric Water Pump



Performance curve

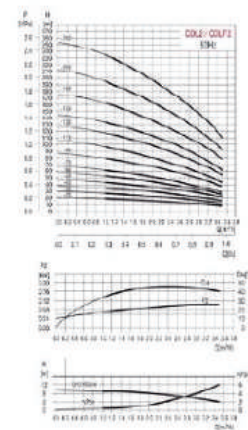

### Electric Motor Single Phase

AC/DC	Single phase
Type	Induction
Voltage	220 V
Protection Class	IP55
Configuration	Capacitor, Aluminum, Small
Torque	Max. : 1.6 Nm (1,1801 ft.lb) Min : 1 Nm (0,7376 ft.lb)
Power	Max. : 5.5 kw (7.478 hp) Min : 0.55 kw (0.748 hp)
Rotational Speed	Max : 2,850 rpm (17,907.08 rad. min-1) Min. : 1,350 rpm (8,482.3 rad.min-1)
Diameter	Max. : 230 mm (9.06 in) Min. : 130 mm (5.12 in)



### Electric Motor Three Phase

AC/DC	three phase
Type	asynchronous
Voltage	400V, 380V, 220V, 230V, 240V, 690V, 660V
Number of poles	2-pole, 4-pole, 6-pole
Applications	agricultural for hydraulic applications, for pumps for ventilators, for air compressors, for elevators for the mining industry, for conveyors
Other characteristics	energy-saving, IE3, IE2, high-efficiency, high orque
Power	Max. : 0.09 kw (0.122hp) Min : 22 kw (29.912 hp)
Rotational Speed	Max : 850 rpm (5,340.71 rad. min-1) Min. : 2,960 rpm (18,598,23 rad, min-1)



## Electric Power Tools

# Power Tools Electric

### Electric Grinder

(100, 115, 130, 140, 180, 220 MM)



### • Electric Drill

(10, 13, 16 MM)



### • Electric Polisher Angle / Vertical

(180, 220 MM)



### • Electric Jig Saw



### • Electric Sander



## Pneumatic Tools

# Pneumatic Tools

- **Impact Wrench**  
(1/2", 3/4", 1")



- **Air Polisher**  
(Vertical / Angle)



- **Air Ratchet**  
(3/8", 1/2")



- **Air Grinder**  
(115, 180 MM)



## Pneumatic Tools

# Pneumatic Tools

- Air Drill  
(10, 13 MM)



- Air Screw Driver



- Air Jig Saw



- Orbital and Dual Sander



## Heavy Duty Hand Tools

# Heavy Duty Hand Tools

### • Sockets & Accessories



### • Spanners



### • Screw drivers



## Heavy Duty Hand Tools

# Heavy Duty Hand Tools

### • Pliers



### • Torque Wrenches



### • Hammers



### • Pullers



### • Plumbing Tools



## Heavy Duty Hand Tools

# Heavy Duty Hand Tools

### • Tool Trolleys and Workbenches



### • Automotive Tools



### • Electrician Tools



### • Bench Vise (Size: 4", 5", 6", 8", 10")

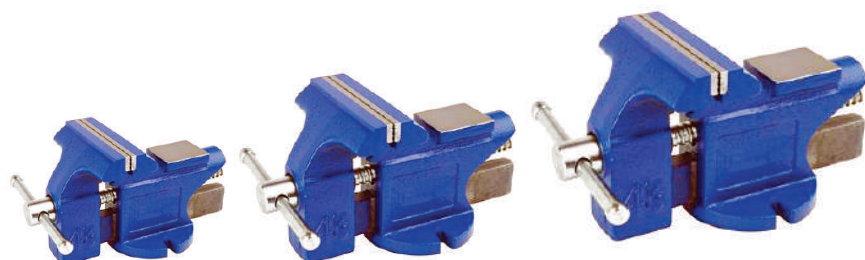

# Fabrication & Machinery Equipment

## Fabrication & Machinery Equipment

- **Drill Press**  
(Pedestal Type)



- **Bench Grinder with stand**  
(Size: 4", 5", 6", 8")



- **Pipe Threading Machine**  
(Manual / Electrical)



- **Pipe Bending Machine**  
(Manual / Hydraulic)

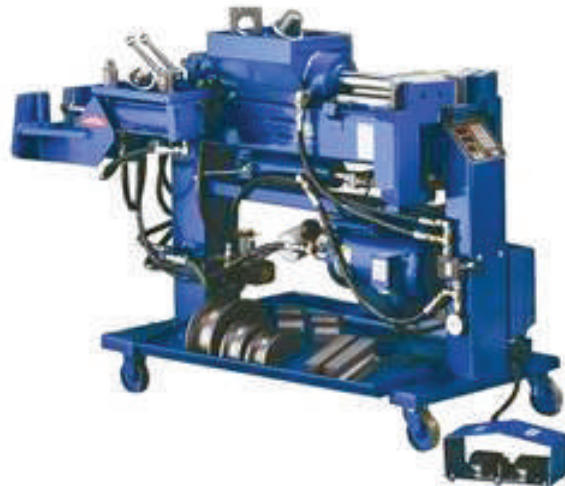

# Fabrication & Machinery Equipment

## Fabrication & Machinery Equipment

• Table Saw



• Circular Saw



• Metal Band Saw



• Block Cutter



# Fabrication & Machinery Equipment

## Fabrication & Machinery Equipment

• Milling Machine

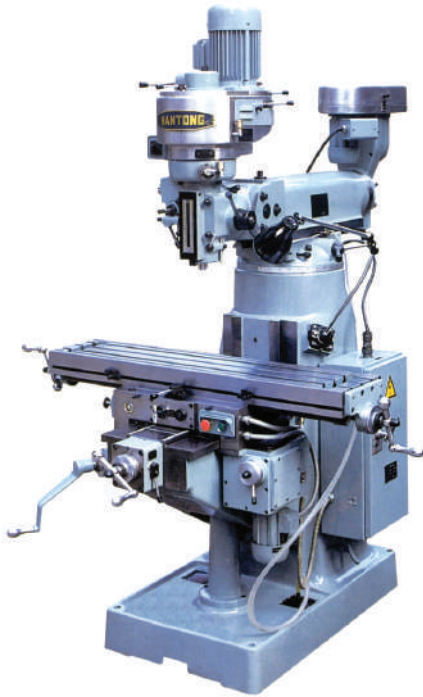

• Electric Cut off Saw



• Hydraulic Press

(10, 12, 15, 20, 30, 50, 100 Ton)



# Handling and Lifting

## Handling and Lifting

### Hand Pallet Truck

- Normal/ with scale
- Capacity: 2, 2.5, 3 Ton



### Platform Truck Capacity

- (150, 300, 400, 500 KG)



### Starker

- Manual/Electric/  
Battery operated
- Capacity:  
0.5, 1, 2, 3 Ton



### Chain

- (Block / Lever Type)
- Capacity:  
1, 1.5, 2, 3, 5, 6, 10



### Drum Lifter

- 200 KG Capacity



### • Parts Trolley



### • Wheel Dolly Heavy Duty



## Generators (Petrol / Diesel)

# Generators (Petrol/Diesel)

### Generator

- a- Manual / Electric Operating
- b- Capacity: 1, 3, 5, 7, 10, 15, 20 KVA
- c- Silent Model / Open Model



- Petrol / Diesel Water Pump  
(Size: 2", 3", 4")



- Petrol / Diesel Welding Generators  
(Capacity: 190, 210 AMP)



## Turn Key Projects

# Turn Key Projects

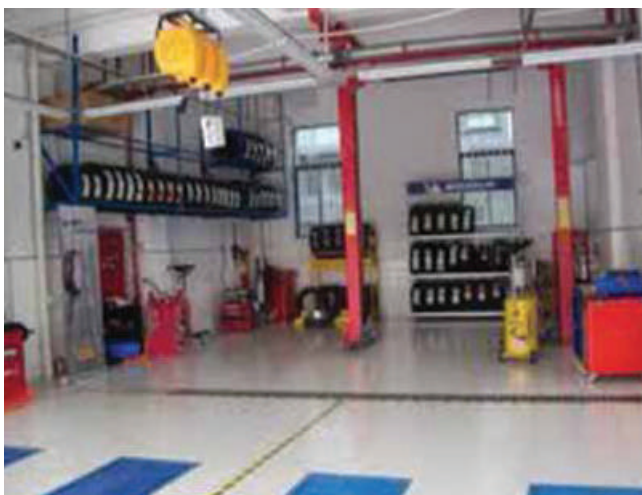
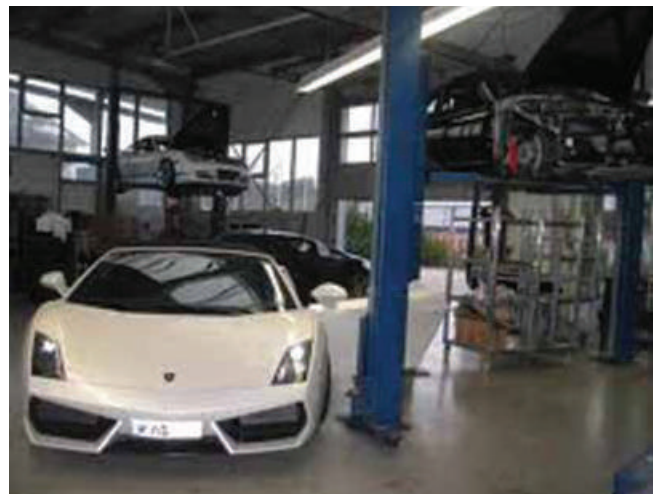
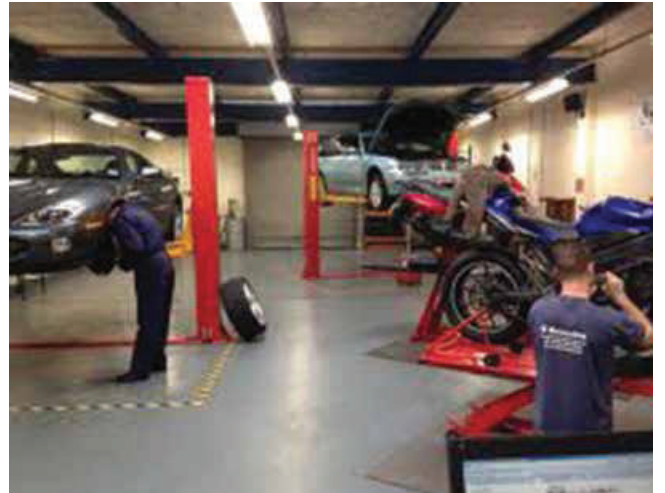

## Turn Key Projects

# Turn Key Projects

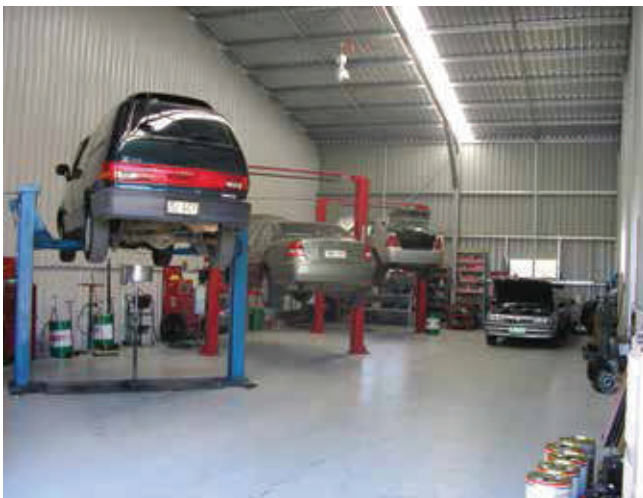

# Product List



## Location (Google Map Location)

# Location

## Sharjah

### Industrial Area 4

1st industrial street

## AUTO PARTS COMPLEX

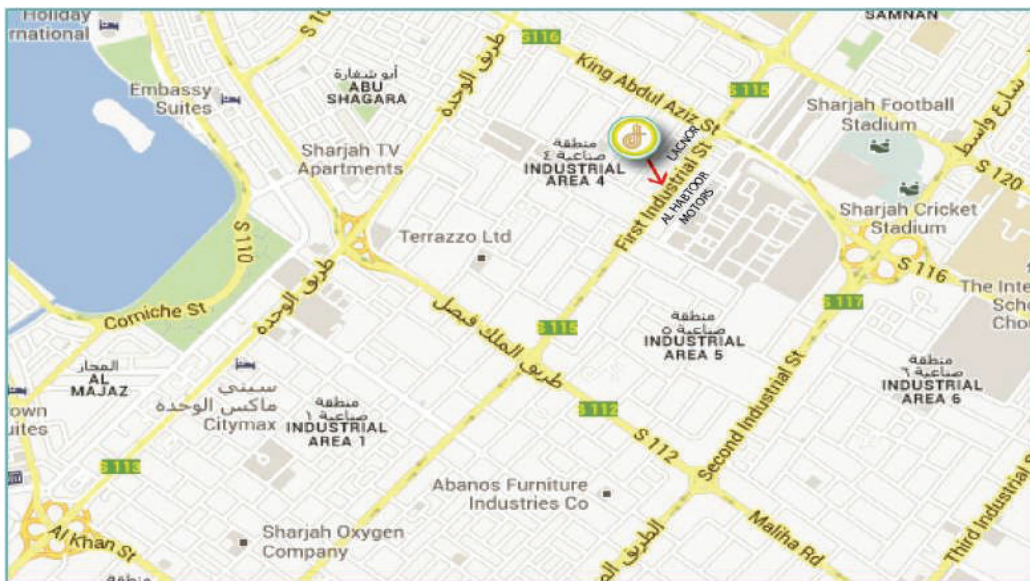

## DUBAI

SHEIKH ZAYED ROAD

AL QUOZ NO. 1

## MIDDLE EAST INTERNATIONAL ENTERPRISES

